

BOGE AIR. THE AIR TO WORK.



PISTON COMPRESSORS

PO Series



To minimise energy use in compressed air generation, we go back to the drawing board again and again.

INNOVATIVE
QUALITY BY
BOGE

When our engineers tackle the next development stage of a product range, the attainable IQ level is the focal point of their deliberations. IQ stands for **INNOVATIVE QUALITY** – the synthesis of proven premium quality and innovative solutions. Each detail is perfected until it is shown to be future-proof. Using this process when developing the new oil-free PO series, we were able to obtain the most efficient and durable motor units, whilst creating an amazingly compact lightweight design. This was downsizing with the focus on efficiency and environmental friendliness.

DESIGN ADVANTAGES OF THE PO SERIES

Over and above significant improvements in efficiency and free air delivery product development targets included reducing noise, creating a compact design and achieving the easiest possible maintenance. The modular design concept guarantees a wide range of product options.

Extensively ribbed aluminium cylinder and aluminium cylinder heads in lightweight design

Silenced suction filter

Direct-coupled drive

Effective close-fitting spiral tube cooler

Space-saving V-configuration cylinder

Hermetically sealed crankshaft bearing

Compact crankcase

Easy-access central distributor block

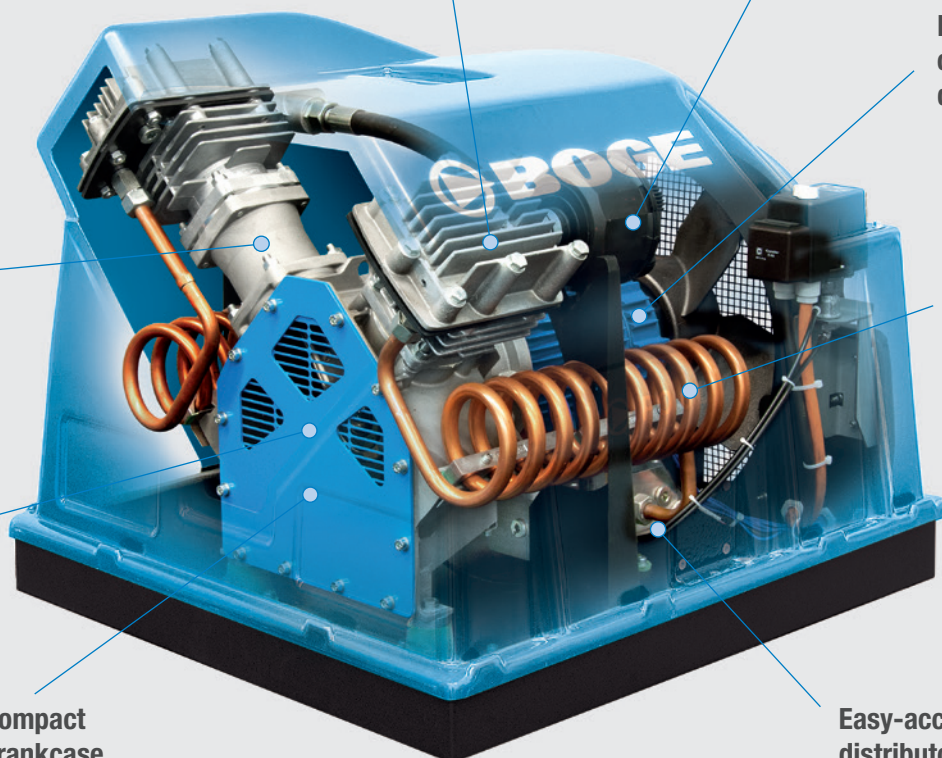

The absolutely oil-free piston compressors in the new BOGE PO series allow high-quality compressed air to be used even in sensitive applications with exemplary efficiency. Particular attention was paid to low-wear operation, while the extremely compact design with the closed hood concept combines operational reliability with environmental friendliness. The PO series meets the requirements of the RoHS Directive (2002/95 /EC).* These are all hallmarks of the high IQ. **INNOVATIVE QUALITY by BOGE.**



ENHANCED DURABILITY

The low piston speed of 3 m/sec. minimises vibrations and keeps the components at a low temperature. This reduces wear, which significantly extends the life of pistons and cylinders.

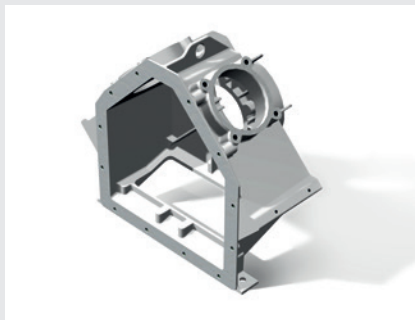

COMPACT DESIGN

The slim compressor design results in a smaller footprint. For the first time, it is also possible to offer an oil-free solution for twin units on top of a compressed air receiver, or compressed air centres with a receiver and a dryer!

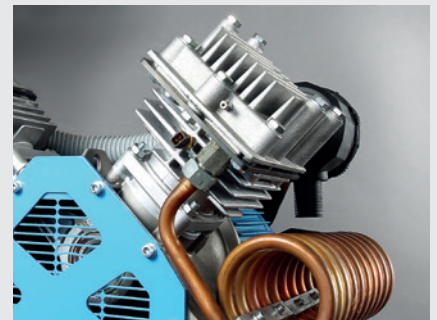

INTERMITTENT OR CONTINUOUS OPERATION

Compressed air users requiring frequent intermittent use are not best served by Screw Compressors. The PO series, however, can be switched on and off repeatedly without any problem, and there is no restriction on the allowable on-time.

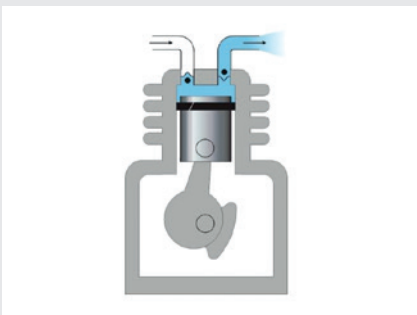

100 PERCENT OIL-FREE

Preventing compressed air from becoming contaminated with oil is only possible if the system is totally free of oil. The BOGE PO series works on a completely oil-free principle and so is particularly suitable for uses such as in paint shops and food processing. For environmentally friendly compressed air, we use specially coated pistons and piston rings, specially developed cylinder liners, and hermetically sealed bearings.

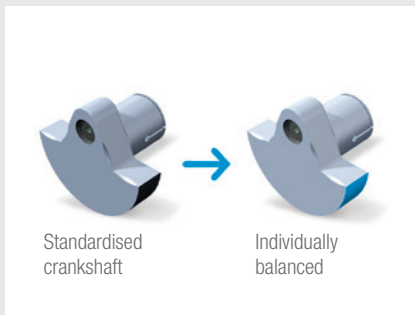

FINELY TUNED CRANKSHAFT

Vibrations can be greatly reduced if each individual crankshaft is meticulously balanced. The use of anti-vibration mounts to decouple components stops vibrations from passing into the floor mounts.

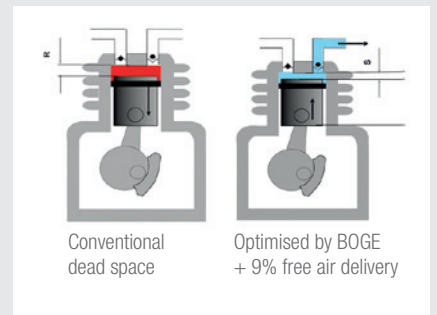

DEAD SPACE PERFECTED

To keep dead space in the cylinder to a minimum, manufacturing tolerances are minimised, valves and valve pockets have been fine-tuned, and the distance rings are individually type-adjusted. Low flow resistances significantly improve the volumetric efficiency – all a matter of IQ orientation.

Advantages of the V-principle: Incredibly **versatile**, absolutely **reliable**, practically **wear-free**.



IDEAL FOR SENSITIVE ENVIRONMENTS WITH FLUCTUATING COMPRESSED AIR DEMAND:

To provide absolutely oil-free compressed air wherever it is crucial, such as medical or food technology, we have optimised the V-principle in the new PO series. High-quality components were put through their paces to achieve minimum wear, optimal accessibility and an extremely compact design.

INNOVATIVE QUALITY ALSO MEANS RE- THINKING TRIED AND TESTED CONCEPTS:

Each innovation must be measured against the proven design. Detail solutions, such as minimising dead space, the innovative piston bearing lubrication system, or the hermetically sealed crankshaft and big-end bearings, demonstrate the potential of the V-configuration: Suddenly, high performance and minimal maintenance procedures are no longer a contradiction.

A long service life and high performance potential – this apparent contradiction is uncompromisingly resolved by the PO series. As well as a marked improvement in efficiency and free air delivery, other development targets included reducing noise, creating a compact design and achieving the easiest possible maintenance.



CLOSED COOLING AIR DUCT HOOD

The cooling air inlet port was generously dimensioned for maximum efficiency. Even so, the closed design of the lightweight and heat-resistant ABS plastic cooling air duct hood is significantly more reliable in use and complies with the “Safety requirements for compressors” in standard EN 1012-1.

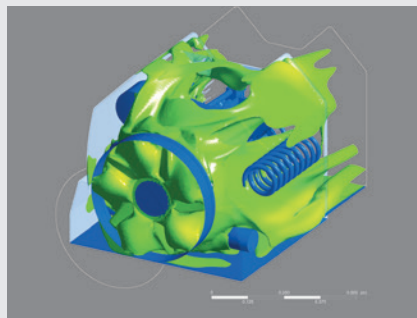

OPTIMISED FLOW

The flow of air over the cylinder was studied in particular detail: Complex speed analysis allowed us to optimise this flow and thereby lower the temperature of the components, resulting in positive impacts not only on the rate of wear but also on the service life.



LIGHTWEIGHT DESIGN FOR FLEXIBLE USE

The days of big and immobile piston compressors are over. Lightweight construction is now the order of the day. This increases potential uses many times over. The compact dimensions, coupled with smooth and quiet operation, are decisive factors in opening up the use of absolutely oil-free compressed air even for special applications such as mobile snow-making.



Absolutely Oil-Free

Hermetically sealed bearings, and no oil in the condensate – the motor units in the PO series are guaranteed to deliver oil-free compressed air. Ideal for sensitive applications.



Outstanding Efficiency

The PO series sets whole new standards in many respects – particularly where free air delivery, durability and energy efficiency are concerned.



Practically Maintenance-Free

The consistent focus on low wear design reduces maintenance work to an occasional filter change, which can be carried out in-house.



Premium Engineering

It's the combination of premium quality with intelligent innovative solutions that sets the PO series apart: INNOVATIVE QUALITY, in fact.

Tailor-Made Thanks to Modular Design – The PO Series with 28 Product Variants.

NARROW FOOTPRINT, WIDE CHOICE!

PO 8 L

The letters PO (Piston Oil-free) in the name mean that this basic unit is an oil-free, directly coupled (L=Line) piston compressor with a motor rating of 8 PS.



PO 8 LR

Many users require a separate storage receiver for the compressed air. The “R” (Receiver) in the name refers to this configuration.



PO 8 LDR

Oil-free piston compressor in combination with a compressed air receiver and a dryer (D= Dryer).



PO 8 LTR

Even as twin units (T=Twin), compressors in the PO series can be combined with a separate receiver for the compressed air.



APPLICATIONS FOR OIL-FREE PISTON COMPRESSORS

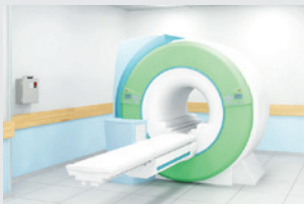

Medical and Pharmaceutical Industry

In sensitive areas such as dentist's surgeries and hospitals, 100% oil-free compressed air from BOGE has been in use for many years. The compact units in the PO series make for even easier installation.



Paint and Spray Finishers

It's only natural that paint shops are not prepared to make concessions where compressed air is concerned. The PO series delivers what it says: There is no chance whatsoever of oil contamination in the compressed air.



Food Industry

Precision-dosed compressed air for bottling beer, for instance, reduces froth to a minimum, and speeds up the bottling process. A case for the PO series.



Water Treatment

Naturally, only compressed air that is 100% oil-free can be used for treating water. This is where the PO series comes into its own – for injecting bubbles of air to promote bacteria growth.

The unique design features of the PO Series meets many different requirements in the working world. Thus they provide the option of one-stage (up to 10 bar) or two-stage (up to 15 bar) compression. The remarkable diversity in the 2.2 kW to 5.5 kW performance segment is made possible by the modular design and the carry-over part approach. This allows the PO series to be individually configured – from individual units with an optional separate dryer and receiver right up to twin units.

BOGE Model	Receiver volume Litres	Max. pressure		Effective free air delivery*		Nominal output drive motor		Dimensions Cooling Air Duct Hood (CADH)	Dimensions silenced	Weight (CADH)	Weight silenced
		bar	psig	l/min	cfm	kW	HP	W x D x H (mm)	W x D x H (mm)	kg	kg
PO 3 L		6	90	268	9,5	2,2	3,0	811 x 759 x 694	1150 x 770 x 800	114	157
		10*	145	246	8,7	2,2	3,0	811 x 759 x 694	1150 x 770 x 800	114	157
PO 3 L		9	130	250	8,8	2,2	3,0	811 x 759 x 757	1150 x 770 x 800	120	172
		15*	218	245	8,6	2,2	3,0	811 x 759 x 757	1150 x 770 x 800	120	172
PO 4 L		6	90	398	14,1	3,0	4,0	811 x 759 x 694	1150 x 770 x 800	120	162
		10*	145	362	12,8	3,0	4,0	811 x 759 x 694	1150 x 770 x 800	120	162
PO 4 L		9	130	294	10,4	3,0	4,0	811 x 759 x 757	1150 x 770 x 800	128	177
		15*	218	288	10,2	3,0	4,0	811 x 759 x 757	1150 x 770 x 800	128	177
PO 6 L		6	90	524	18,5	4,0	5,5	811 x 759 x 694	1150 x 770 x 800	127	187
		10*	145	512	18,1	4,0	5,5	811 x 759 x 694	1150 x 770 x 800	127	187
PO 6 L		9	130	452	16,0	4,0	5,5	811 x 759 x 757	1150 x 770 x 800	136	192
		15*	218	450	16,0	4,0	5,5	811 x 759 x 757	1150 x 770 x 800	136	192
PO 8 L		6	90	704	24,9	5,5	8,0	811 x 759 x 694	1150 x 770 x 800	137	207
		10*	145	668	23,6	5,5	8,0	811 x 759 x 694	1150 x 770 x 800	137	207
PO 3 LR	270	10	145	246	8,7	2,2	3,0	1141 x 759 x 1110	1705 x 770 x 1410	182	293
	350	15	218	245	8,6	2,2	3,0	1380 x 785 x 1309	1735 x 780 x 1465	210	341
PO 4 LR	270	10	145	362	12,8	3,0	4,0	1141 x 759 x 1110	1705 x 770 x 1410	188	298
	350	15	218	288	10,2	3,0	4,0	1380 x 785 x 1309	1735 x 780 x 1465	205	346
PO 6 LR	270	10	145	512	18,1	4,0	5,5	1141 x 759 x 1110	1705 x 770 x 1410	212	323
	350	15	218	450	16,0	4,0	5,5	1380 x 785 x 1309	1735 x 780 x 1465	226	371
PO 8 LR	270	10	145	668	23,6	5,5	8,0	1141 x 759 x 1110	1705 x 770 x 1410	222	343
PO 3 LDR	270	10	145	246	8,7	2,2	3,0	1380 x 759 x 1223	1735 x 770 x 1450	222	328
	350	15	218	245	8,6	2,2	3,0	1380 x 785 x 1309	1750 x 780 x 1505	250	376
PO 4 LDR	270	10	145	362	12,8	3,0	4,0	1380 x 759 x 1223	1735 x 770 x 1450	228	332
	350	15	218	288	10,2	3,0	4,0	1380 x 785 x 1309	1750 x 780 x 1505	290	381
PO 6 LDR	270	10	145	512	18,1	4,0	5,5	1380 x 759 x 1223	1735 x 770 x 1450	252	357
	350	15	218	450	16,0	4,0	5,5	1380 x 785 x 1309	1750 x 780 x 1505	266	396
PO 8 LDR	270	10	145	668	23,6	5,5	8,0	1380 x 759 x 1223	1735 x 770 x 1450	262	379
PO 3 LTR	270	10	145	2 x 246	2 x 8,7	2 x 2,2	2 x 3,0	1950 x 750 x 1300	–	336	–
	350	15	218	2 x 245	2 x 8,6	2 x 2,2	2 x 3,0	1950 x 770 x 1430	–	358	–
PO 4 LTR	270	10	145	2 x 362	2 x 12,8	2 x 3,0	2 x 4,0	1950 x 750 x 1300	–	348	–
	350	15	218	2 x 288	2 x 10,2	2 x 3,0	2 x 4,0	1950 x 770 x 1430	–	400	–
PO 6 LTR	270	10	145	2 x 512	2 x 18,1	2 x 4,0	2 x 5,5	1950 x 750 x 1300	–	362	–
	350	15	218	2 x 450	2 x 16,0	2 x 4,0	2 x 5,5	1950 x 770 x 1430	–	432	–
PO 8 LTR	270	10	145	2 x 668	2 x 23,6	2 x 5,5	2 x 8,0	1950 x 750 x 1300	–	382	–

* Free air delivery according to VDMA 4362 at 80% max. pressure. Emitted sound pressure levels from 79 dB(A) according to PN8NTC2.3

BOGE Compressed Air Systems GmbH & Co. KG

P.O. Box 10 07 13 · 33507 Bielefeld

Otto-Boge-Straße 1–7 · 33739 Bielefeld

Tel. +49 5206 601-0 · Fax +49 5206 601-200

info@boge.com · www.boge.com

Best
Of
German
Engineering

In more than 120 countries worldwide customers from mechanical engineering, industry and trade trust the BOGE know-how in planning, development and production of high quality compressed air systems. Already in its fourth generation, the family-owned company puts all its experience in the development of innovative solutions and outstanding efficient products for the compressed air industry.

Rightly, therefore, the last name of the founder Otto Boge stands for „Best Of German Engineering“ today. Who puts emphasis on German engineering skills, highest safety, reliable services and energy efficiency, accesses quality products from BOGE because they have been supplying „the air to work“ for more than 100 years.

OUR RANGES OF SERVICES INCLUDE THE FOLLOWING:

- Energy efficient systems development
- Plant design and engineering
- Industry 4.0 solutions, system control and visualisation
- High Speed Turbo compressors
- Oil-free piston, screw and scroll compressors
- Oil injected screw compressors and oil lubricated piston compressors
- Compressed air treatment
- Compressed air distribution and storage
- Compressed air accessories
- Compressed air service
- Nitrogen and oxygen generators

